

**Model : 3870EA-D
EZ15 PLUS**

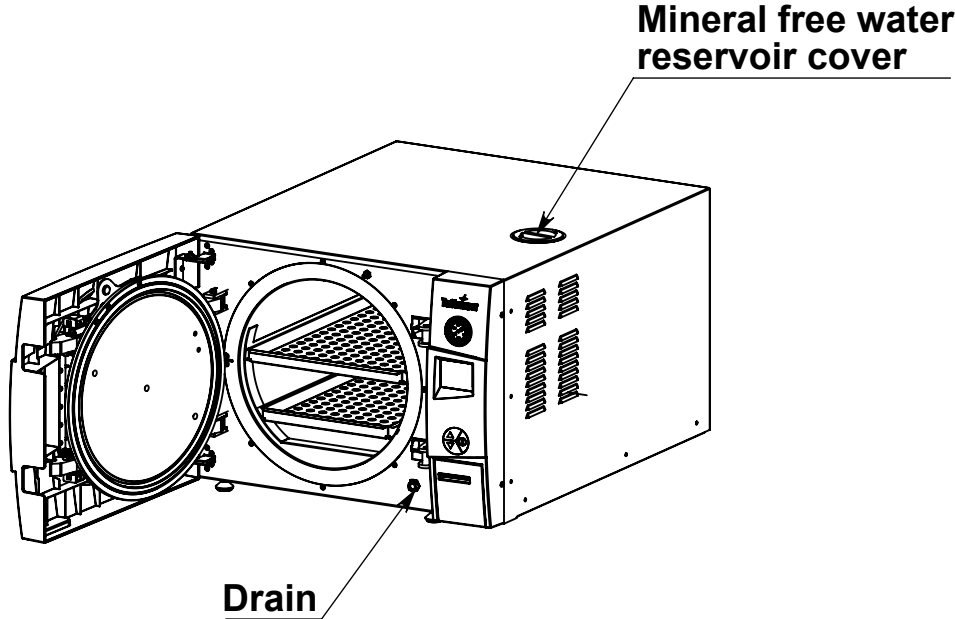
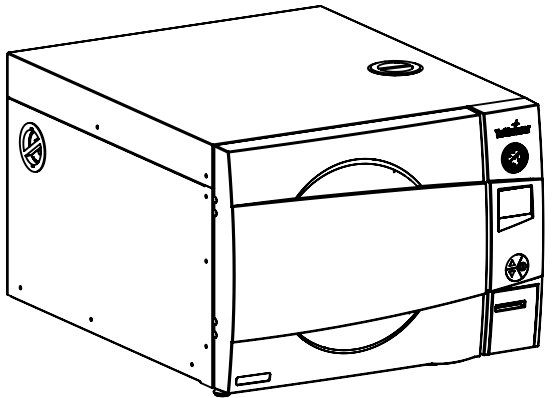
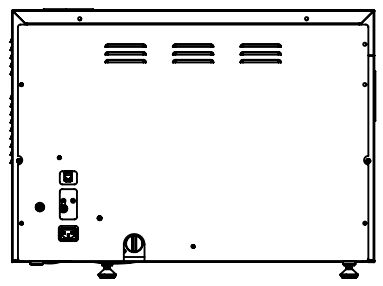
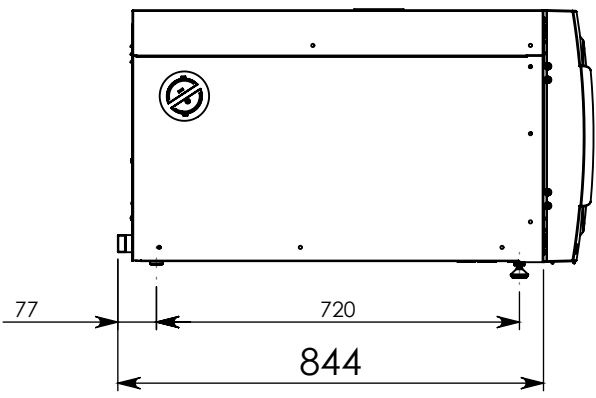
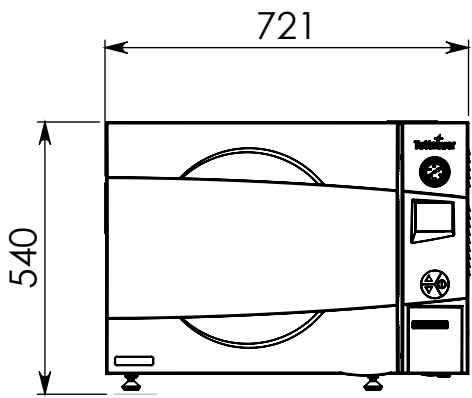

All dimension are in millimeters